

# DAVIS®

*Always Ahead™*

## Underfloor Trunking System

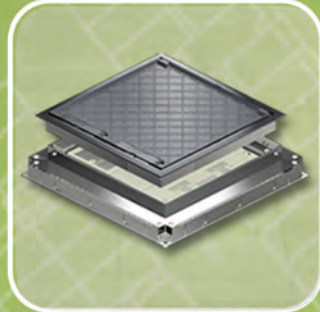
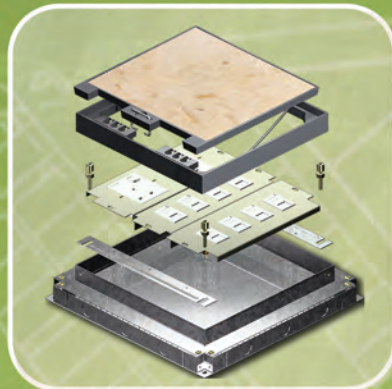

BS IEC CE KEMA

[www.davis.com.my](http://www.davis.com.my)





Davis, well known for introducing modern underfloor cable management system 60 years ago, is a pioneer in cable management systems. Today, Davis remains at the forefront of the cable management industry.

With more than half a century of cable management leadership and technology, Davis continues to innovate and improvise its vast range of cable management products which complies with the most stringent technical specifications and the highest standards of today's modern office requirements.

Davis has of a team of dynamic and dedicated pool of design engineers and professional sales force, providing first class service and support for the company's wide range of products. Our people will always be there to ensure all its high-performance products meet the ever changing trends and demands of smart homes, stylish office designs, intelligent building structures and sophisticated monumental skyscrapers.

At Davis, we always produce what the market wants. We always keep up with new challenges of the electrical industry. Davis adopts a policy of continuous improvement, producing competitively priced products and is committed to give excellent customer service which keeps us *"Always Ahead"*.









With strategically located manufacturing and support facilities and an extensive distribution network across the region, Davis is well positioned to meet every exact need and requirement of our customers all over the world.

DAVIS range of products includes:-

- Modular Flushfloor Trunking System
- Raised Floor Trunking System
- Underfloor Trunking System
- Heavy Duty Underfloor Trunking System
- 63A 240/415V Raised Floor Bustrack System
- 200A – 6300A Busway System

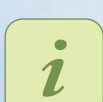
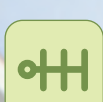



	<b>INTRODUCTION</b>	<b>1</b>
	<b>UNDERFLOOR TRUNKING</b>	<b>2</b>
	<b>UNDERFLOOR SERVICE BOXES</b>	<b>3 - 6</b>
	<b>UNDERFLOOR LAYOUT VIEW</b>	<b>7 - 8</b>
	<b>UNDERFLOOR JUNCTION BOXES</b>	<b>9 - 10</b>
	<b>TECHNICAL DATA</b>	<b>11 - 12</b>
	<b>LAYOUT DESIGN</b>	<b>13</b>
	<b>CABLE CAPACITY GUIDE</b>	<b>13</b>
	<b>INSTALLATION GUIDE</b>	<b>14</b>
	<b>ACCESSORIES</b>	<b>15 - 16</b>







## INTRODUCTION

DAVIS Underfloor Trunking System is designed for the distribution of power, voice and data services in floors where the trunking is buried in the screed. This system provides the simplest and most economical method of carrying services to feed a grid of outlet installation and can be used to integrate with perimeter or surface trunking systems.

DAVIS Underfloor Trunking System consists of the following components :

uPVC Underfloor Trunking  
Vertical Access Boxes  
Service Outlet Boxes

Metal Underfloor Trunking  
Junction Boxes  
Pedestal Boxes

## FEATURE BENEFITS

- Constructed from pre-galvanized steel sheets in accordance with BS 4678 : Part 2, BS EN 50085-2-2 & IEC 61084-2-2.
- Trap & frame tested to withstand 4.5kN concentrated load. Underfloor trunking (screeded) tested to withstand 30kN concentrated load.
- The system incorporates numerous design features to ensure a fast and simple installation.
- Designed to support CAT 6 structured cabling systems.
- Suitable for screeded depth from 56mm to 85mm.
- Floor boxes are IP30 rated in accordance with BS EN 60529.
- Choice of 1, 2, 3 or 4 compartment floor boxes.
- Wide range of power and data accessories available to meet all requirements.

## UNDERFLOOR TRUNKING

### METAL TRUNKING

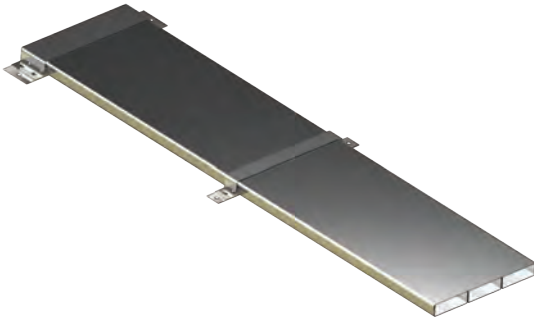

DAVIS Underfloor Trunking is produced from pre-galvanized steel sheets in accordance with BS 4678 : Part 2, BS EN 10327, IEC 61084-2-2 & BS EN 50085-2-2. This method of construction by utilizing channels avoids damage to its galvanized coating to prevent corrosion. This also adds strength to the section whilst allowing site adaptation, where necessary. The individual channels are held together by clamping saddles with connecting saddles for ducting joints. The trunking is produced in standard 2.3 or 2.44 meter lengths. Each trunking comes with 2 clamping saddles and a connecting saddle.

### UPVC TRUNKING



### UPVC UNDERFLOOR TRUNKING

Trunking Size W X H X T (mm)	No. of Compart.	Section Rectangular
50X25X2.5	1	P5025
75X25X2.5	1	P7525
75X25X3.2	1	P7532
100X25X2.7	1	P10027
100X25X3.2	1	P10032
75X38X3.2	1	P7532/38
100X38X3.2	1	P10032/38

\*Std. Length 2.9 meters

### UNDERFLOOR METAL TRUNKING

Trunking Size W X H (mm)	Model	
	1 Compart.	2 Compart.
150X25	EUFT150/1/25	EUFT150/2/25
150X38	EUFT150/1/38	EUFT150/2/38
	2 Compart.	3 Compart.
225X25	EUFT225/2/25	EUFT225/3/25
250X25	EUFT250/2/25	EUFT250/3/25
300X25	EUFT300/2/25	EUFT300/3/25
225X38	EUFT225/2/38	EUFT225/3/38
250X38	EUFT250/2/38	EUFT250/3/38
300X38	EUFT300/2/38	EUFT300/3/38

### VERTICAL ACCESS BOX

For Trunking W X H (mm)	No. of Compart.	For uPVC Trunking	For Metal Trunking
150X25	1	EUFV150/1/25/U	EUFV150/1/25
150X25	2	EUFV150/2/25/U	EUFV150/2/25
225X25	2	EUFV225/2/25/U	EUFV225/2/25
225X25	3	EUFV225/3/25/U	EUFV225/3/25
250X25	3	EUFV250/3/25/U	EUFV250/3/25
300X25	3	EUFV300/3/25/U	EUFV300/3/25
150X38	1	EUFV150/1/38/U	EUFV150/1/38
150X38	2	EUFV150/2/38/U	EUFV150/2/38
225X38	2	EUFV225/2/38/U	EUFV225/2/38
225X38	3	EUFV225/3/38/U	EUFV225/3/38
250X38	3	EUFV250/3/38/U	EUFV250/3/38
300X38	3	EUFV300/3/38/U	EUFV300/3/38

### SPECIFICATIONS

Pre-galvanized steel sheets to BS EN 10142 or BS EN 10327 or JIS G3302.

Body and Cover 1.2mm.

Other Underfloor Trunking sizes are also available. Please contact our sales office for further details.

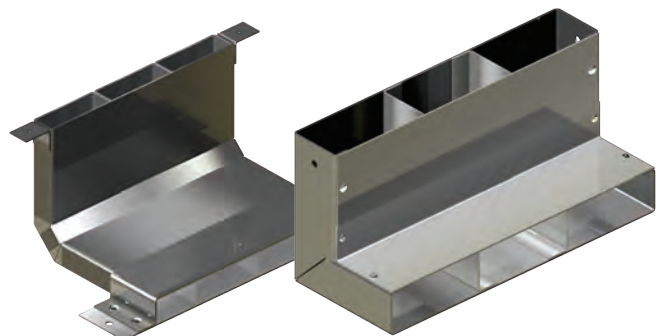

FOR METAL TRUNKING

FOR uPVC TRUNKING



### UNDERFLOOR SERVICE BOXES

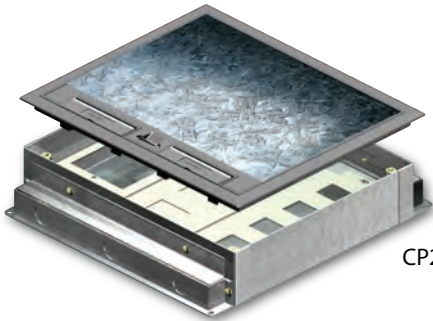

CP270/xxx

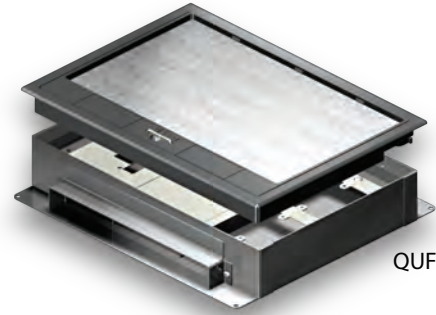

QUFSxxx

#### CP270 6MM RECESS

L X W X H (mm)	Model		Trk Entry W X H (mm)
	2 Compart.	3 Compart.	
270X230X56	CP270/225/2/25	CP270/225/3/25	225X25
270X230X69	CP270/225/2/38	CP270/225/3/38	225X38
270X230X56	CP270/250/2/25	CP270/250/3/25	250X25
270X230X69	CP270/250/2/38	CP270/250/3/38	250X38

\* The trap and frame are moulded from flame retardant engineering plastics (Nylon 66) reinforced with pre-galvanized steel sheets infill plate.

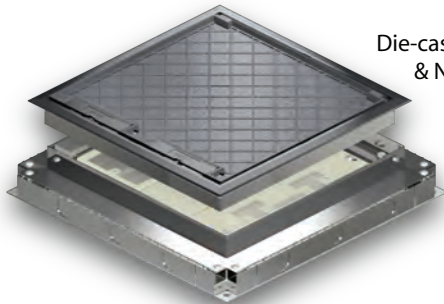

Die-cast Alloy Trap & Nylon Frame  
CP470/xxx

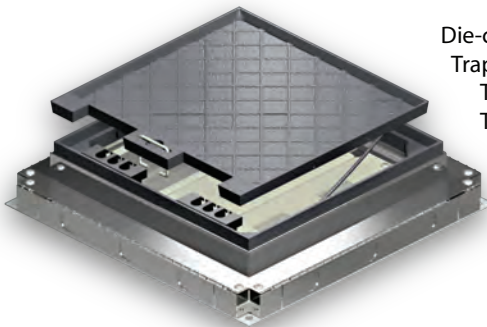

Die-cast Alloy Trap & Frame  
TF470/xxx  
TF370/xxx

Metal Trap & Frame  
UFS125/xxx

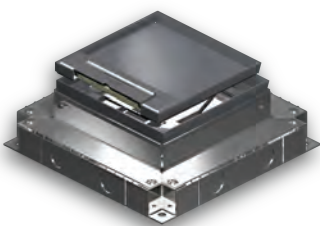

Metal Trap & Frame  
UFS125250/xxx

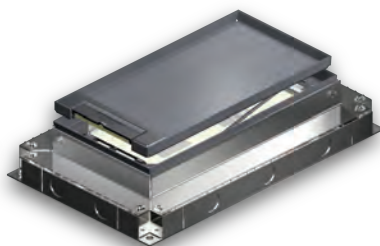

\* The metal type trap & frame are made from 1.6mm pre-galvanized steel sheets with epoxy finish.

#### QUANTEC 6MM RECESS

L X W X H (mm)	Model		Trk Entry W X H (mm)
	2 Compart.	3 Compart.	
339X244X56	QUFS225/2/25	QUFS225/3/25	225X25
339X244X56	QUFS250/2/25	QUFS250/3/25	250X25
339X244X56	QUFS300/2/25	QUFS300/3/25	300X25
339X244X69	QUFS225/2/38	QUFS225/3/38	225X38
339X244X69	QUFS250/2/38	QUFS250/3/38	250X38
339X244X69	QUFS300/2/38	QUFS300/3/38	300X38

\* The trap and frame are moulded from high impact flame retardant ABS plastic reinforced with pre-galvanized steel sheets infill plate.

#### DIE-CAST ALLOY 6MM RECESS

L X W X H (mm)	Model		Trk Entry W X H (mm)
	2 Compart.	3 Compart.	
250X250X56	CP470/2/25	CP470/3/25	225X25
250X250X69	CP470/2/38	CP470/3/38	225X38

\* The trap is made of high pressure die-cast alloy. The frame, grommet handles and hinges are moulded from flame retardant engineering plastics (Nylon 66) to give greater mechanical strength.

#### DIE-CAST ALLOY 9MM RECESS

L X W X H (mm)	Model		Trk Entry W X H (mm)
	2 Compart.	3 Compart.	
250X250X56	TF470/2/25	TF470/3/25	225X25
300X300X56	TF370/2/25	TF370/3/25	300X25
250X250X69	TF470/2/38	TF470/3/38	225X38
300X300X69	TF370/2/38	TF370/3/38	300X38

\* The trap and frame are made of high pressure die-cast alloy.

#### METAL 125X250 9MM RECESS

L X W X H (mm)	Model		Trk Entry W X H (mm)
	1 Compart.	2 Compart.	
125X250X56	UFS125250/1/25/M/9	UFS125250/2/25/M/9	125 / 250X25
125X250X69	UFS125250/1/38/M/9	UFS125250/2/38/M/9	125 / 250X38

#### METAL 125X125 9MM RECESS

L X W X H (mm)	Model	Trk Entry W X H (mm)
	1 Compart.	
125X125X56	UFS125/1/25/M/9	125X25
125X125X69	UFS125/1/38/M/9	125X38

## UNDERFLOOR SERVICE BOXES



**QUANTEC  
SERVICE  
BOX**

### Quantec Trap and Frame

- 6mm recess.
- made of flame retardant, high impact ABS plastic.
- trap is prevented from detachment by a unique hinge mechanism.
- trap opens up to maximum 80° and is self-closing.
- colour comes in light grey.
- trap is reinforced with pre-galvanized steel sheets infill plate for maximum strength and durability.

### Handle

- stainless steel handle to improve accessibility and durability.

### Grommet with Cable Retainer

- enable the trap to be shut flat while cable protruding safely through the grommet.

### Flanged Frame

- to prevent carpet from fraying out.

### Compartment Segregation

- boxes available in 1, 2 and 3 compartments.

### Basic Box

- screed depths: (refer to Technical Data - Pg 12)
- rated IP30 in accordance with BS EN 60529.
- provided with disposable lid to prevent ingress during screeding.
- optional side plate pierced to accept 20mm and 25mm conduits are also available.

### Flap Cover

- retractable when not in use and to prevent the ingress of dust.

### Levelling System

- to adapt to final floor level by a maximum upward lift of 16mm. (refer to Pg 12 for details)

### Base Plate Fixing

- provision for fastening the box to ease installation.

## SPECIFICATIONS

### Basic Box:

Pre-galvanized steel sheets to BS EN 10142, BS EN 10327 or JIS G3302.

## UNDERFLOOR SERVICE BOXES



**CP470  
SERVICE  
BOX**



### Flap Handle with Cable Retainer

- enable the trap to be shut flat while cable protruding safely through the grommet.

### Levelling System

- to adapt to final floor level by a max upward lift of 16mm. (refer to Pg 12 for details)

### Compartment Segregation

- boxes available in 1, 2 and 3 compartments.

### Basic Box

- screed depths: (refer to Technical Data - Pg 12)
- rated IP30 in accordance with BS EN 60529.
- provided with disposable lid to prevent ingress during screeding.

### Trap and Frame

- 6mm recess.
- available in metal and die-cast alloy.
- trap is prevented from detachment by a unique hinge mechanism.
- sizes 125x125 & 125x250 available in pre-galvanized steel sheets with epoxy finish.
- trap opens up to 180° flat.

### Frame

- flanged edge to prevent carpet from fraying out.

### 90° Box Rotation

- via brackets that can be installed in either of 2 sides (for square box only).

### Side Plates

- come with perforation to accept trunking and knockout holes pierced to accept 20mm conduits (25mm trunking height) or 25mm conduits (38mm trunking height).

### Base Plate Fixing

- provision for fastening the box to ease installation.

## SPECIFICATIONS

### Basic Box:

Pre-galvanized steel sheets to BS EN 10142, BS EN 10327 or JIS G3302.



### UNDERFLOOR SERVICE BOXES



**TF470  
SERVICE  
BOX**



#### Grommet with Cable Retainer

- enable the trap to be shut flat while cable protruding safely through the grommet.



#### Handle

- stainless steel handle to improve accessibility and durability.

#### Trap and Frame

- 9mm recess.
- available in die-cast alloy.
- trap is prevented from detachment by a unique hinge mechanism.
- sizes 125x125 & 125x250 available only in pre-galvanized steel sheets with epoxy finish.
- trap opens up to 180° flat.

#### Levelling System

- to adapt to final floor level by a maximum upward lift of 16mm. (refer to Pg 12 for details)

#### Compartment Segregation

- boxes available in 1, 2 and 3 compartments.

#### 90° Box Rotation

- via brackets that can be installed in either of 2 sides (for square box only).

#### Side Plates

- come with perforation to accept trunking and knockout holes pierced to accept 20mm conduits (25mm trunking height) or 25mm conduits (38mm trunking height).

#### Basic Box

- screed depths: (refer to Technical Data - Pg 12)
- rated IP30 in accordance with BS EN 60529.
- provided with disposable lid to prevent ingress during screeding.

#### Base Plate Fixing

- provision for fastening the box to ease installation.

## SPECIFICATIONS

### Basic Box:

Pre-galvanized steel sheets to BS EN 10142, BS EN 10327 or JIS G3302.

UNDERFLOOR LAYOUT VIEW

VERTICAL ACCESS BOX

- is specifically designed to access the electrical distribution system or a surface trunking system.

TRUNKING SYSTEM

- constructed from pre-galvanized steel sheets in accordance with BS 4678 : Part 2, BS EN 50085-2-2 & IEC 61084-2-2. Tested under screeding to withstand 30kN concentrated load.

FLOOR FINISHING

- wide range of sizes are available to suit various finishings such as carpet, vinyl tiles, ceramic tiles, marble and wooden floors.

CLAMPING SADDLE

- used to fix the trunking to the base floor.

CONNECTING SADDLE

- used to secure 2 lengths of trunking together without the ingress of screed during screeding.



ACCESSORIES

- a full range of accessories such as floor pedestal boxes, round grommets, extension screw terminals, offsets, etc., are available.

TRAP / FRAME

- wide range of sizes of trap / frame engineered from high pressure die-cast alloy with epoxy finish or engineering plastics are available.

SERVICE OUTLET BOX

- adapts to a universal range of panel-mounted accessories for power, data and voice services.

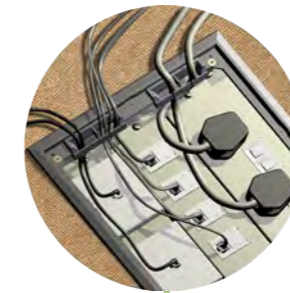

SAFE EARTHING

- A separate earth wire is attached from the basic box to the trap to provide 100% earth continuity.



PRE-GALVANIZED STEEL FLYOVER

- a two-piece flyover to ease the pulling of cables.
- compartment segregation and protection from electromagnetic interferences via a steel flyover in compliance with IEE regulations.



DISPOSABLE LID

- floor box is provided with disposable lid to prevent ingress during screeding.

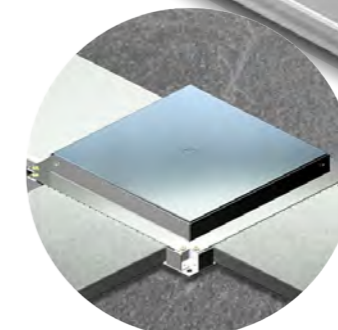



### UNDERFLOOR JUNCTION BOXES

Die-cast Alloy Trap  
& Nylon Frame  
CP460/xxx

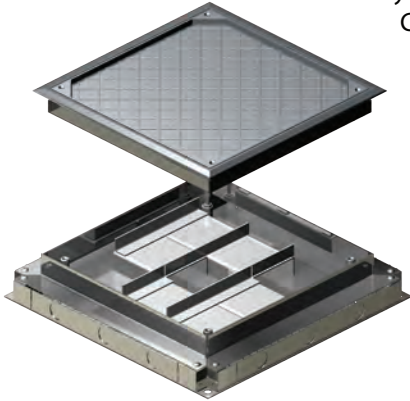

#### DIE-CAST ALLOY 6MM RECESS

L X W X H (mm)	Model		Trk Entry W X H (mm)
	2 Compart.	3 Compart.	
250X250X56 250X250X69	CP460/2/25 CP460/2/38	CP460/3/25 CP460/3/38	250X25 250X38

\* The trap is made of high pressure die-cast alloy. The frame, grommet handles and hinges are moulded from engineering plastic (Nylon 66) which gives greater mechanical strength.

#### DIE-CAST ALLOY 9MM RECESS

L X W X H (mm)	Model		Trk Entry W X H (mm)
	1 Compart.		
125X125X56 125X125X69	TF125/1/25 TF125/1/38		125X25 125X38
		2 Compart.	3 Compart.
250X250X56 250X250X69	TF460/2/25 TF460/2/38	TF460/3/25 TF460/3/38	250X25 250X38
300X300X56 300X300X69	TF360/2/25 TF360/2/38	TF360/3/25 TF360/3/38	300X25 300X38

\* The trap and frame are made of high pressure die-cast alloy.

Die-cast Alloy  
Trap & Frame  
TF125/xxx  
TF460/xxx  
TF360/xxx

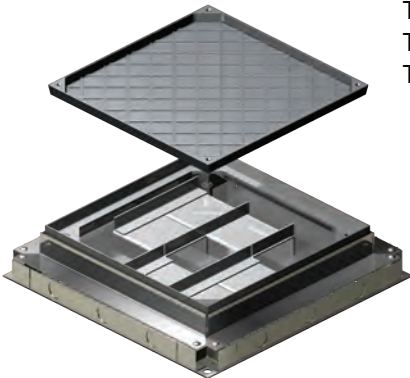

#### METAL 270 X 270 6MM RECESS

L X W X H (mm)	Model		Trk Entry W X H (mm)
	2 Compart.	3 Compart.	
270X270X56 270X270X69	UFJ270/225/2/25/M/6 UFJ270/225/2/38/M/6	UFJ270/225/3/25/M/6 UFJ270/225/3/38/M/6	225X25 225X38
270X270X56 270X270X69	UFJ270/250/2/25/M/6 UFJ270/250/2/38/M/6	UFJ270/250/3/25/M/6 UFJ270/250/3/38/M/6	250X25 250X38

\* The metal trap and frame are made from 1.6mm pre-galvanized steel sheets reinforced with pre-galvanized steel sheets on the trap.

Metal  
Trap & Frame  
UFJ270/xxx

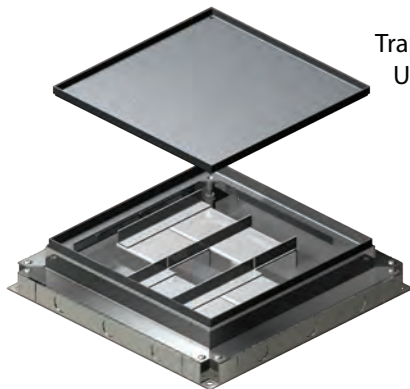

#### SPECIFICATIONS

##### Basic Box:

Pre-galvanized steel sheets to BS EN 10142,  
BS EN 10327 or JIS G3302.

### UNDERFLOOR JUNCTION BOXES



#### JUNCTION BOXES

#### Trap and Frame

- 6mm and 9mm recesses.
- plain type is also available.
- available in die-cast alloy and metal.

#### Junction Box

- allows for 'through', 'tee', 'elbow' and 'cross' configurations.
- supports CAT 6 compliance.

#### Frame

- flanged edge to prevent carpet from fraying out.

#### Pre-galvanized Steel Flyover

- a two-piece flyover to ease the pulling of cables.
- compartment segregation and protection from electromagnetic interferences via a steel flyover in compliance with IEE regulations.

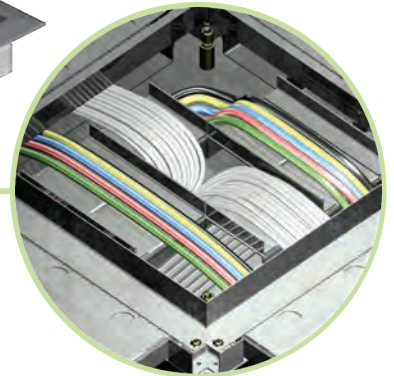

#### Levelling System

- to adapt to final floor level by a maximum upward lift of 16mm. (refer to Pg 12 for details)

#### Side Plates

- come with perforation to accept trunking and knockout holes pierced to accept 20mm conduits (25mm trunking height) or 25mm conduits (38mm trunking height).

#### Basic Box

- screed depths: (refer to Technical Data - Pg 12)
- rated IP30 in accordance with BS EN 60529.
- provided with disposable lid to prevent ingress during screeding.

#### Base Plate Fixing

- provision for fastening the box to ease installation.

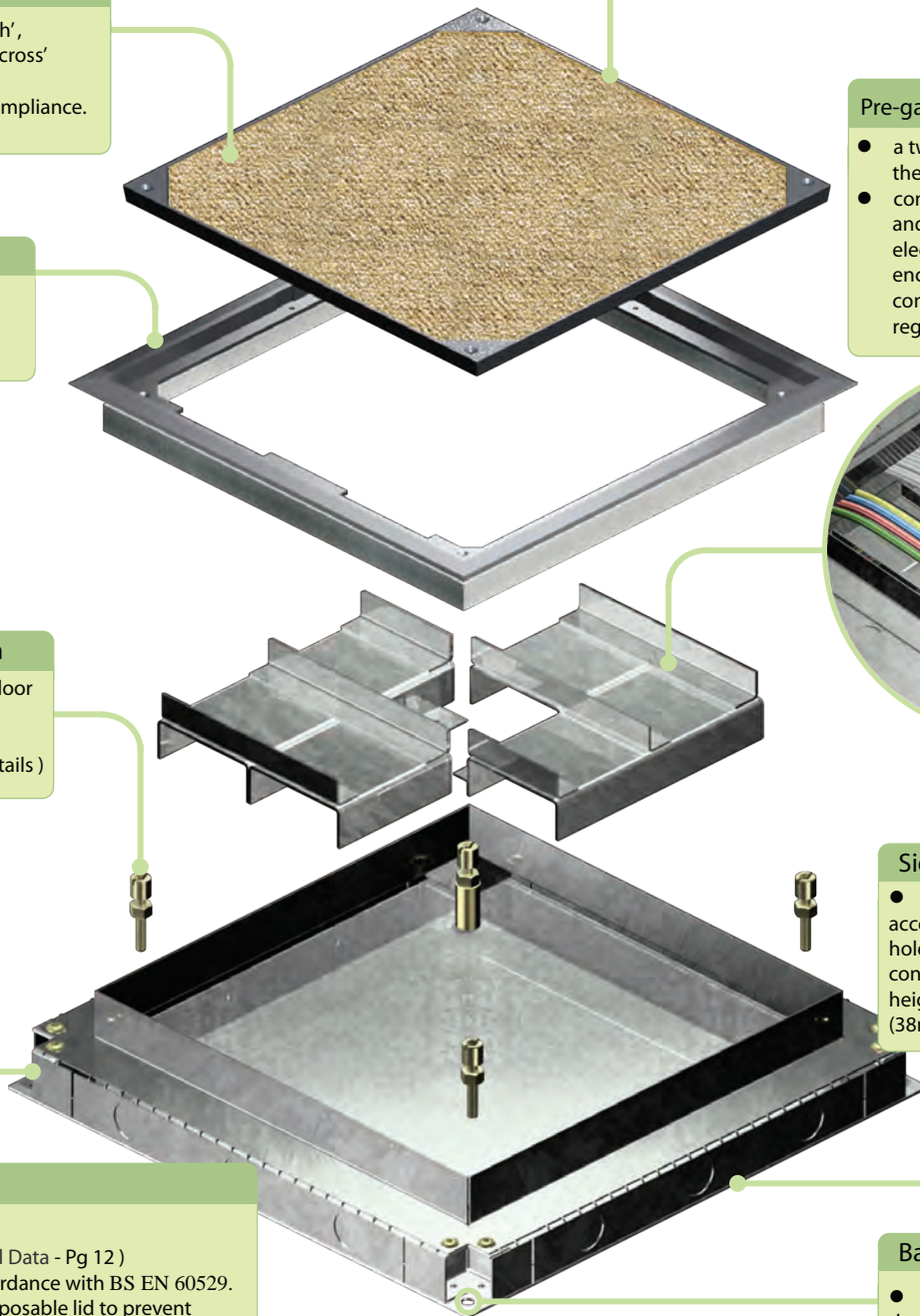





## TECHNICAL SPECIFICATIONS

## Underfloor Trunking

Material	Pre-galvanized steel sheets in accordance with BS EN 10142, BS EN 10327 or JIS G3302.
Strength	Tested under screeding to withstand 30 kN concentrated load.
International Standards	The trunking supplied shall comply with BS 4678 : Part 2, BS EN 50085-2-2 & IEC 61084-2-2.
Construction	Construction of the trunking is by channel method. This is to avoid damage to its galvanized coating to prevent corrosion. This method also adds strength to the section whilst allowing site adaptation. The top channel has continuous side returns to prevent the ingress of screed and is clamped to the base channels with two clamping saddles and a double width connecting saddle.
Standard thickness	1.2mm
Standard lengths	2.3 or 2.44 meters
No. of Compartments	2 and 3 compartments
Standard heights	25mm and 38mm

## Junction Box / Service Outlet Box

Material	250x250mm or 300x300mm constructed from pre-galvanized steel sheets, suitable for screed depths from 56mm to 85mm with provision for trunking entry on four sides or 20mm conduits (for 25mm trunking height) or 25mm conduits (for 38mm trunking height) on blank sides. A throwaway lid shall be provided to prevent the ingress of screed during installation.
Strength	DAVIS underfloor boxes shall be able to withstand the following load tests:- <ol style="list-style-type: none"> <li>Concentrated load test – 3.0kN @25mm sq. steel platen.</li> <li>Concentrated load test – 4.5kN @300mm sq. steel platen.</li> <li>Uniform distributed load test – 8.0kN/m<sup>2</sup>.</li> <li>Maximum deflection shall not exceed 3mm for these loadings (BS EN 50085-2-2).</li> </ol>
Construction	Covers (traps and frames) for the service outlet box and junction box shall be constructed from 3mm thick high-pressure die-cast alloy or 3mm thick pre-galvanized steel sheets with epoxy finish or plastic reinforced with 2.5mm ( 4.5kN ) and 3mm ( 6.0kN ) thick pre-galvanized infill steel sheets plate. All are available in 6mm recess for carpet finish or 9mm recess for tile finish.
Lid Opening	Service outlet cover shall be able to be flat open through 180°. It comes with cable grommets and cable retainers. Junction box cover is shut flat and secured by counter sunk screws.
Electromagnetic Compatibility	Junction Box shall be provided with pre-galvanized steel sheets flyover for compartment segregation. Due to electromagnetic interferences, the use of plastic flyover is not suitable. This is to comply with the latest I.E.E regulations. A service outlet box shall have fully segregated outlet panels to isolate the services in compliance with the latest I.E.E regulations.



## TECHNICAL DATA

### FOR 25MM TRUNKING HEIGHT

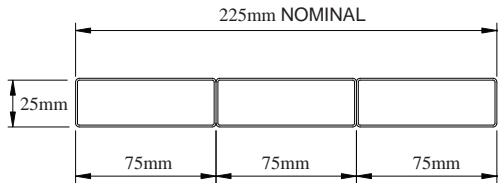

uPVC TRUNKING  
(STANDARD 75mm X 25mm)

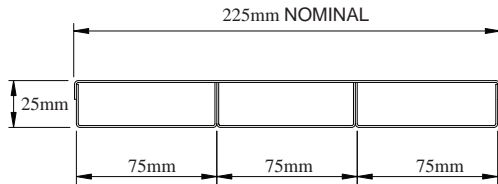

UNDERFLOOR TRUNKING  
(STANDARD 25mm TRUNKING HEIGHT)

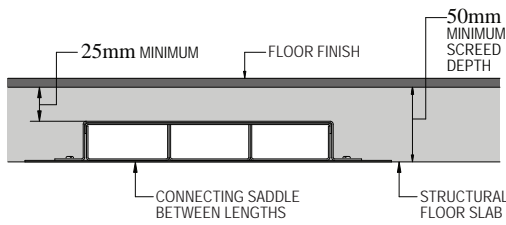

SCREEDING DEPTH

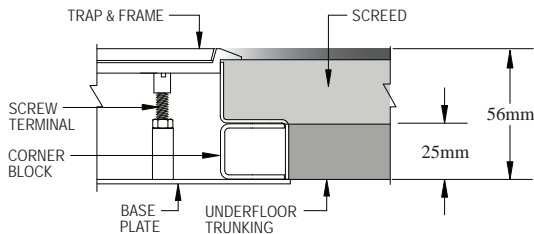

DAVIS underfloor boxes can be adjusted to suit screed depth of between 56mm and 72mm.

FLOOR BOX DEPTH

### FOR 38MM TRUNKING HEIGHT

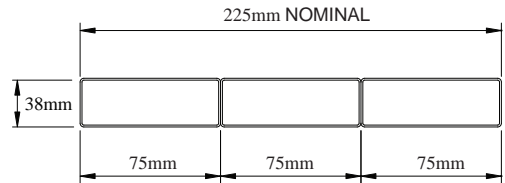

uPVC TRUNKING  
(STANDARD 75mm X 38mm)

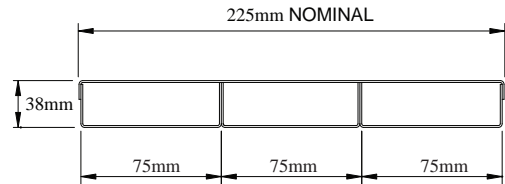

UNDERFLOOR TRUNKING  
(STANDARD 38mm TRUNKING HEIGHT)

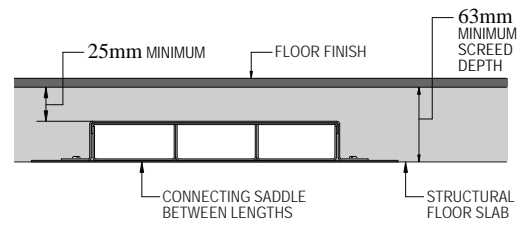

SCREEDING DEPTH

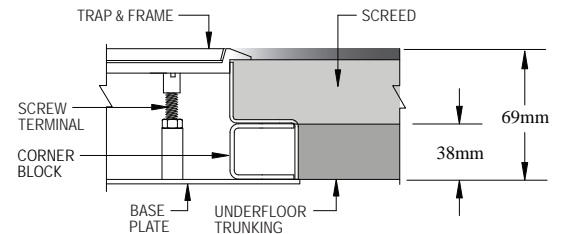

DAVIS underfloor boxes can be adjusted to suit screed depth of between 69mm and 85mm. Higher floor box depth is also available.

FLOOR BOX DEPTH





## LAYOUT DESIGN

### A COMB DESIGN

More suitable for low density service area. This pattern uses less trunking and offers an extremely cost-effective solution. This design is typically used for modular flushfloor, raised floor and underfloor systems.

### A FISHBONE DESIGN

Widely used in areas where tenants require a good degree of flexibility in reorganizing work areas. This design is typically used for modular flushfloor, raised floor and underfloor systems.

### A GRID DESIGN

Most widely used pattern where the tenants require a greater degree of flexibility in reorganizing work areas. This pattern allows the work place capacity to be increased and the capacity of rewiring through individual ring networks. This design is typically used for modular flushfloor and underfloor systems.

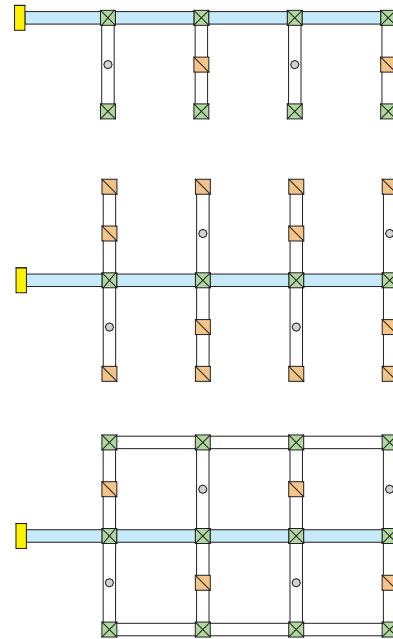

- Service Outlet Box
- Universal Junction Box
- Vertical Access Box
- Header Runs
- Pedestal Box



## CABLE CAPACITY GUIDE

			uPVC Underfloor Trunking					Underfloor Metal Trunking											
			50x25x1C	75x25x1C	100x25x1C	75x38x1C	100x38x1C	100x25 x1C	100x38 x1C	225x25 x2C	225x25 x3C	225x38 x2C	225x38 x3C	250x25 x2C	250x25 x3C	300x25 x2C	300x25 x3C	300x38 x2C	300x38 x3C
Capacity (mm <sup>2</sup> ) per compartment (45% fill)			405	630	783	975	1331	993	1564	1120	738	1764	1163	1247	823	1501	993	2365	1564
	<b>CSA</b> (mm <sup>2</sup> /mm)	<b>Cable Factor</b>	Capacity (no.) per compartment (45% fill)																
<b>Power Cables</b>																			
PVC Stranded	1.5 mm <sup>2</sup>	8.6	47	73	91	113	154	115	181	130	85	205	135	144	95	174	115	274	181
	2.5 mm <sup>2</sup>	12.6	32	50	62	77	105	78	124	88	58	139	92	98	65	119	78	187	124
	4 mm <sup>2</sup>	16.6	24	37	47	58	80	59	94	67	44	106	70	75	49	90	59	142	94
	6 mm <sup>2</sup>	21.2	19	29	36	46	62	46	73	52	34	83	54	58	38	70	46	111	73
	10 mm <sup>2</sup>	35.3	11	17	22	27	37	28	44	31	20	49	32	35	23	42	28	66	44
	16 mm <sup>2</sup>	47.8	8	13	16	20	27	20	32	23	15	36	24	26	17	31	20	49	32
Twin & Earth	2.5 mm <sup>2</sup>	86	4	7	9	11	15	11	18	13	8	20	13	14	9	17	11	27	18
	4 mm <sup>2</sup>	99	4	6	7	9	13	10	15	11	7	17	11	12	8	15	10	23	15
	6 mm <sup>2</sup>	148	2	4	5	6	8	6	10	7	4	11	7	8	5	10	6	15	10
<b>Data Cables</b>																			
CAT 5e UTP	5.5 dia	30.2	13	20	25	32	44	32	51	37	24	58	38	41	27	49	32	78	51
CAT 5e STP	6 dia	36	11	17	21	27	36	27	43	31	20	48	32	34	22	41	27	65	43
CAT 6 UTP	6.5 dia	42.2	9	14	18	23	31	23	37	26	17	41	27	29	19	35	23	56	37
CAT 6 STP	7 dia	49	8	12	15	19	27	20	31	22	15	35	23	25	16	30	20	48	31

The table above gives the available capacity units on 45% factor ( IEE Wiring Regulation ), applied to internal wiring area and serves as a guideline only.

## G

## INSTALLATION GUIDE

The structural floor slab shall be level and smooth. Humps and protruding cement must be hacked to level to ensure the trunking being laid will maintain the minimum screed thickness of 25mm over the trunking. It is also recommended that a mesh such as chicken wire mesh be placed over the trunking runs to prevent screed damage or cracking at a later stage.

**Step 1:** Use trunking layout drawing to select a fixed starting point for installation, for instance a junction box. Tie two guide lines approximately 150mm above the floor slab at 90° to each other. Position the junction box below the intersection of the guide lines.

**Step 2:** Position the floor boxes and trunkings to reflect the layout drawing. The junction box's position can be used as a reference point. Bend 90° up the perforated section of the box's side plate. Insert the trunking approximately 40mm into the box.

**Step 3:** Use connecting and clamping saddles to secure all screw connections and to fasten the trunkings to the slab. Use base plate holes provided to fasten floor box to the slab.

**Step 4:** The box should be properly covered with a disposable lid and taped to prevent the ingress of cement during screeding. The disposable lid top can be set as a screed depth datum. The system is now ready for screeding to take place.

**Step 5:** Once the screed is completely dried, the disposable lid can be removed, and the box interiors can be fitted. Use the levelling system to adjust the box height to reach the level of the required screed depth (box is factory set to 56mm or 69mm). Once the wiring is completed, the trap and frame can then be installed. Should extra wiring space/ plug top clearance be required, use levelling system to top up the space.

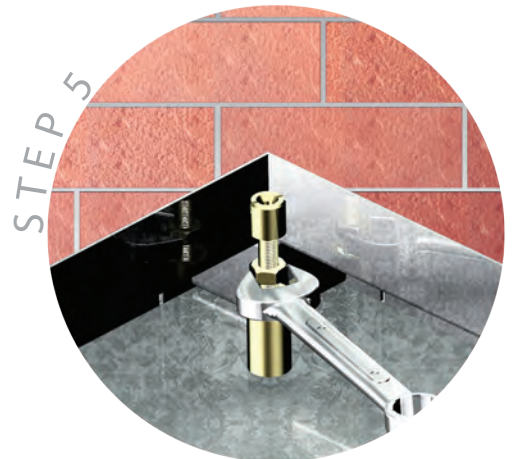
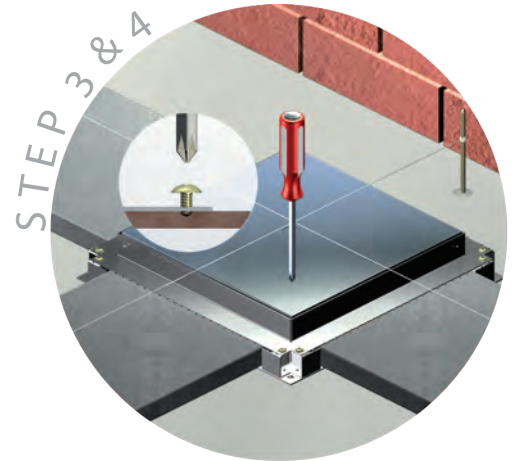
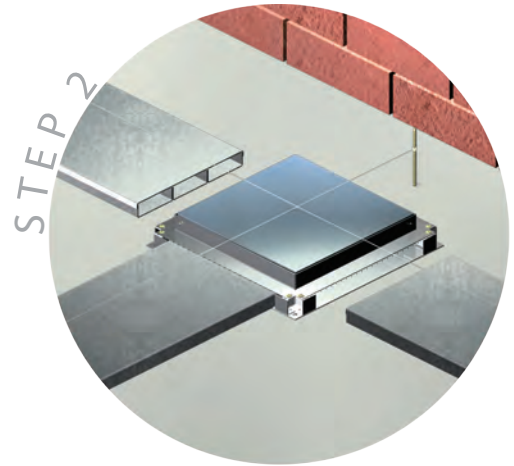
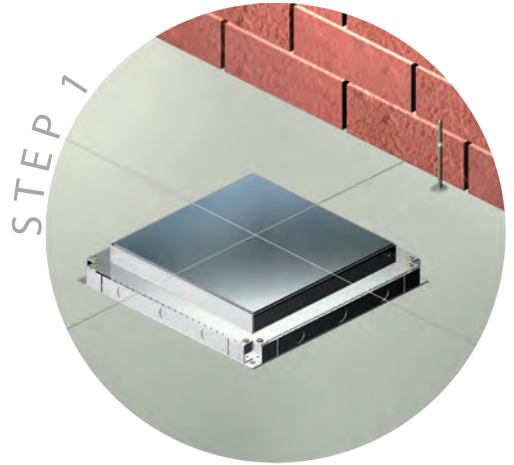



### OUTLET PANELS

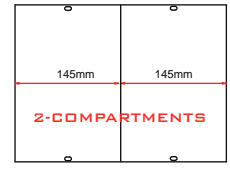
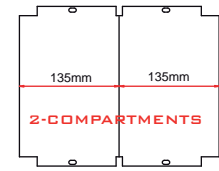
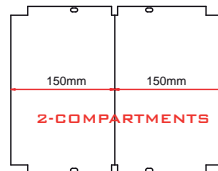
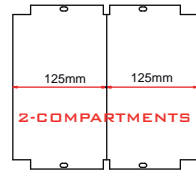
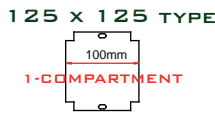
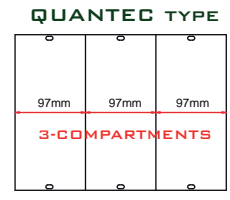
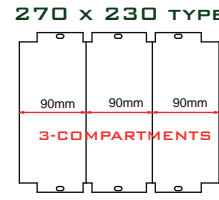
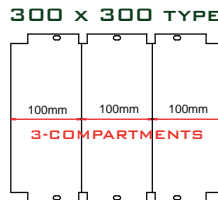
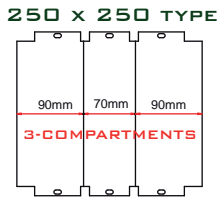
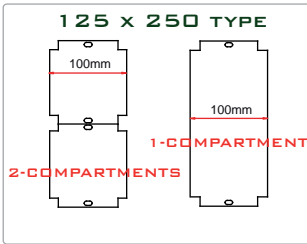
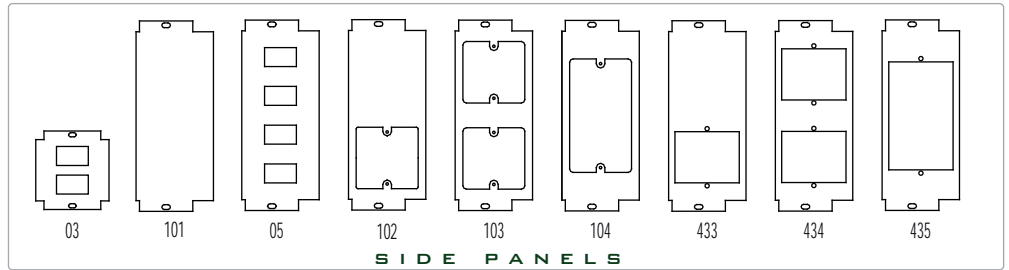
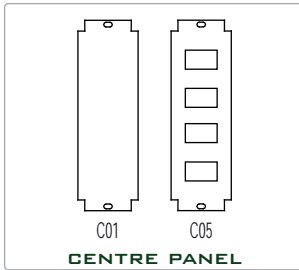

Description	125 x 125		125 x 250		250 x 250		QUANTEC		
	1-Comp.	1-Comp.	2-Comp.	2-Comp.	3-Comp.		2-Comp.	3-Comp.	4-Comp.
					CENTRE	SIDES			
Blank plate				OP125 101	OP70 C01	OP90 101	ST145 C01	ST97 C01	SF72 C01
2 nos. Cut-out RJ45 37x22.5mm	OP125 03S		OP125 03D						
4 nos. Cut-out RJ45 37x22.5mm		OP100 05D		OP125 05	OP70 C05	OP90 05	SF145 C05	ST97 C05	SF72 C05
Cut-out in accordance to BS4662 1G	OP125 102S	OP100 102D	OP125 102D	OP125 102		OP90 102	SF145 102	ST97 102	
Cut-out in accordance to BS4662 2x1G		OP100 103D		OP125 103		OP90 103	SF145 103	ST97 103	
Cut-out in accordance to BS4662 2 G		OP100 104D		OP125 104		OP90 104	SF145 104	ST97 104	
1G 13A DAVIS Switched Socket Outlet	OP125 433S	OP100 433D	OP125 433D	OP125 433		OP90 433	SF145 433	ST97 433	
2x1G 13A DAVIS Switched Socket Outlet		OP100 434D		OP125 434		OP90 434	SF145 434	ST97 434	
2G 13A DAVIS Switched Socket Outlet		OP100 435D		OP125 435		OP90 435	SF145 435	ST97 435	

Description	300 x 300			270 x 230		
	2-Comp.	3-Comp.		2-Comp.	3-Comp.	
		CENTRE	SIDES		CENTRE	SIDES
Blank plate	OP150 101	OP100 C01	OP100 101	OP135 2 101	OP90 2 C01	OP90 2 101
4 nos. Cut-out RJ45 37x22.5mm	OP150 05	OP100 C05	OP100 05	OP135 2 05	OP90 2 C05	OP90 2 05
Cut-out in accordance to BS4662 1G	OP150 102	OP100 C102	OP100 102	OP135 2 102	OP90 2 C102	OP90 2 102
Cut-out in accordance to BS4662 2x1G	OP150 103	OP100 C103	OP100 103	OP135 2 103	OP90 2 C103	OP90 2 103
Cut-out in accordance to BS4662 2 G	OP150 104	OP100 C104	OP100 104	OP135 2 104	OP90 2 C104	OP90 2 104
1G 13A DAVIS Switched Socket Outlet	OP150 433	OP100 C433	OP100 433	OP135 2 433	OP90 2 C433	OP90 2 433
2x1G 13A DAVIS Switched Socket Outlet	OP150 434	OP100 C434	OP100 434	OP135 2 434	OP90 2 C434	OP90 2 434
2G 13A DAVIS Switched Socket Outlet	OP150 435	OP100 C435	OP100 435	OP135 2 435	OP90 2 C435	OP90 2 435

Note : All outlet panels supplied are epoxy coated. Non-standard outlet panels are also available upon request.

### 13A SWITCHED SOCKET OUTLETS - SIDE WIRE ENTRY

DAVIS one and two gang 13A Switched Socket Outlets are specially designed to be slim (24mm) with side wire entries to suit underfloor service boxes.

Rating / Standard : 240V, 13A a.c. / BS 1363 : Part 2

3 terminals to : 4x2.5mm<sup>2</sup> cables each or 3x4.0mm<sup>2</sup> cables each accommodate

Approved by : JKR & Suruhanjaya Tenaga

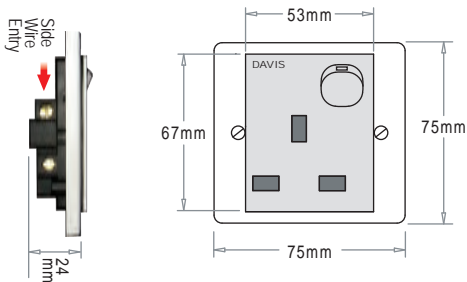

Model	Description
D13/1GS	1 Gang 13A Switched Socket
D13/1GSN	1 Gang 13A Switched Socket with Neon
D13/1GS RD	1 Gang 13A Switched Socket with Red Dolly
D13/1GSN RD	1 Gang 13A Switched Socket with Neon and Red Dolly

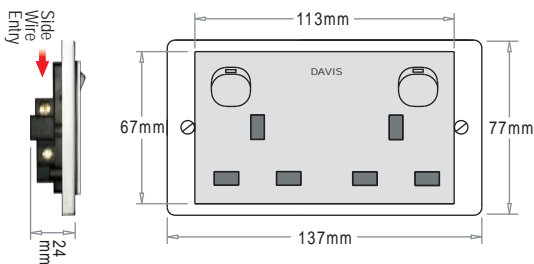

Model	Description
D13/2GS	2 Gang 13A Switched Socket
D13/2GSN	2 Gang 13A Switched Socket with Neon
D13/2GS RD	2 Gang 13A Switched Socket with Red Dolly
D13/2GSN RD	2 Gang 13A Switched Socket with Neon and Red Dolly

### UNDERFLOOR BOX EXTENSION SCREW TERMINALS

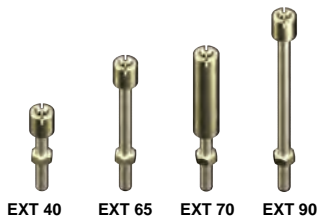

Model	Description
EXT 70 + EXT 65	120 - 160mm
EXT 90	95 - 120mm
EXT 65	75 - 95mm
EXT 40	STANDARD ( 50 - 72mm )

### DATA & TELEPHONE OUTLETS

DAVIS modular type RJ45 & RJ11 data outlets are specially designed to suit underfloor service boxes.

Comply with : TIA/EIA-568-B specifications

Come with : IDC connector and shutter

Hole cut-out : 37mm x 22.5mm

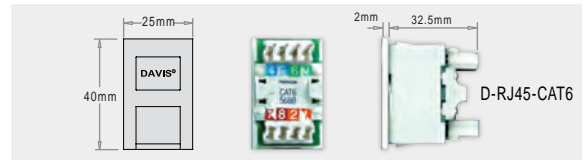

Model	Description
D-RJ11	4-Way RJ11 Telephone Socket Outlet
D-RJ45	CAT 5e RJ45 Data Outlet - TIA/EIA-568-B
D-RJ45-CAT6	CAT 6 RJ45 Data Outlet - TIA/EIA-568-B

### SERVICE ACCESS GROMMETS

DAVIS Service Access Grommet provides a convenient and low-cost solution to data, power and voice services for raised access floors. Recommended cut-out hole is  $\phi 127$ mm.

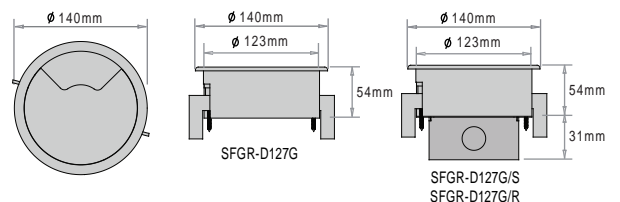

Model	Description
SFGR-D127G	5" Service Access Grommet w/o Box
SFGR-D127G/S	5" Service Access Grommet c/w 1 Gang 13A Switched Socket Outlet
SFGR-D127G/R	5" Service Access Grommet c/w 2 nos. RJ45 / RJ11 Knock out Hole

### FLOOR PEDESTAL BOXES

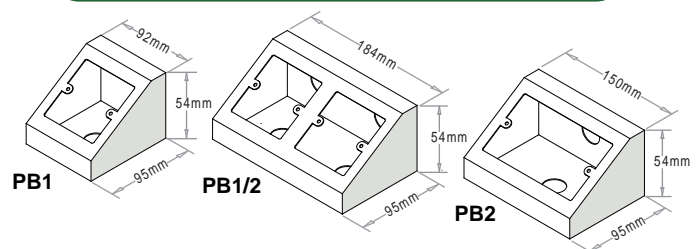

DAVIS Pedestal Boxes are available in 3 designs : 1 gang, 2 x 1 gang and 2 gang for mounting onto Underfloor or Flushfloor Trunkings. They are constructed from pre-galvanized steel sheets with epoxy finish. The socket outlet fixing are in accordance with BS 4662.



# DAVIS®

*Always Ahead™*

**DAVIS MALAYSIA SDN. BHD.** (336731-A)

Lot 526, Jalan Rantau Panjang, Batu 11,

42500 Teluk Panglima Garang,

Kuala Langat, Selangor, Malaysia.

Tel: +60 3 3122 2488 Fax: +60 3 3122 2482

Enquiries : [davis95@streamyx.com](mailto:davis95@streamyx.com)

Website: [www.davis.com.my](http://www.davis.com.my)



The information contained in this brochure has been carefully compiled but is for guidance only, and we do not accept any responsibility for loss caused by any error contained herein.

We reserve the right to alter designs and specifications without prior notice, in line with our policy of continuous product improvement.

Printed in Malaysia